

DATA SHEET

BFG10; BFG10/X NPN 2 GHz RF power transistor

Product specification
Supersedes data of 1995 Mar 07
File under Discrete Semiconductors, SC14

1995 Aug 31

NPN 2 GHz RF power transistor

BFG10; BFG10/X

FEATURES

- High power gain
- High efficiency
- Small size discrete power amplifier
- 1.9 GHz operating area
- Gold metallization ensures excellent reliability.

APPLICATIONS

- Common emitter class-AB operation in hand-held radio equipment at 1.9 GHz.

PINNING

PIN	DESCRIPTION
BFG10 (see Fig.1)	
1	collector
2	base
3	emitter
4	emitter
BFG10/X (see Fig.1)	
1	collector
2	emitter
3	base
4	emitter

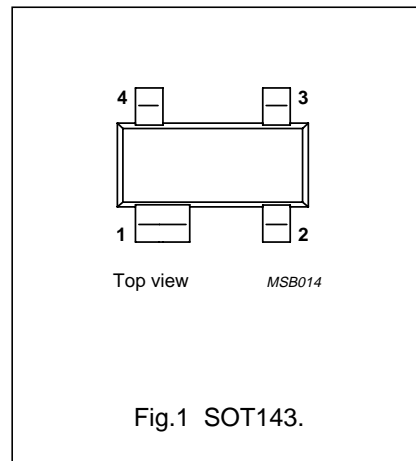

DESCRIPTION

NPN silicon planar epitaxial transistor encapsulated in plastic, 4-pin dual-emitter SOT143 package.

MARKING

TYPE NUMBER	CODE
BFG10	N70
BFG10/X	N71

QUICK REFERENCE DATA

RF performance at $T_{amb} = 25\text{ }^\circ\text{C}$ in a common-emitter test circuit (see Fig.7).

MODE OF OPERATION	f (GHz)	V_{CE} (V)	P_L (mW)	G_p (dB)	η_c (%)
Pulsed, class-AB, duty cycle: < 1 : 8	1.9	3.6	200	≥ 5	≥ 50

LIMITING VALUES

In accordance with the Absolute Maximum Rating System (IEC 134).

SYMBOL	PARAMETER	CONDITIONS	MIN.	MAX.	UNIT
V_{CB0}	collector-base voltage	open emitter	-	20	V
V_{CEO}	collector-emitter voltage	open base	-	8	V
V_{EBO}	emitter-base voltage	open collector	-	2.5	V
I_C	collector current (DC)		-	250	mA
$I_{C(AV)}$	average collector current		-	250	mA
P_{tot}	total power dissipation	up to $T_s = 60\text{ }^\circ\text{C}$; see Fig.2; note 1	-	400	mW
T_{stg}	storage temperature		-65	+150	$^\circ\text{C}$
T_j	junction temperature		-	175	$^\circ\text{C}$

Note

1. T_s is the temperature at the soldering point of the collector pin.

NPN 2 GHz RF power transistor

BFG10; BFG10/X

THERMAL CHARACTERISTICS

SYMBOL	PARAMETER	CONDITIONS	VALUE	UNIT
$R_{th\ j-s}$	thermal resistance from junction to soldering point	up to $T_s = 60\text{ }^\circ\text{C}$; note 1; $P_{tot} = 400\text{ mW}$	290	K/W

Note

- T_s is the temperature at the soldering point of the collector pin.

CHARACTERISTICS

$T_j = 25\text{ }^\circ\text{C}$ unless otherwise specified.

SYMBOL	PARAMETER	CONDITIONS	MIN.	MAX.	UNIT
$V_{(BR)CBO}$	collector-base breakdown voltage	open emitter; $I_C = 0.1\text{ mA}$	20	–	V
$V_{(BR)CEO}$	collector-emitter breakdown voltage	open base; $I_C = 5\text{ mA}$	8	–	V
$V_{(BR)EBO}$	emitter-base breakdown voltage	open collector; $I_E = 0.1\text{ mA}$	2.5	–	V
I_{CES}	collector leakage current	$V_{CE} = 5\text{ V}$; $V_{BE} = 0$	–	100	μA
h_{FE}	DC current gain	$I_C = 50\text{ mA}$; $V_{CE} = 5\text{ V}$	25	–	
C_c	collector capacitance	$I_E = i_e = 0$; $V_{CB} = 3.6\text{ V}$; $f = 1\text{ MHz}$	–	3	pF
C_{re}	feedback capacitance	$I_C = 0$; $V_{CE} = 3.6\text{ V}$; $f = 1\text{ MHz}$	–	2	pF

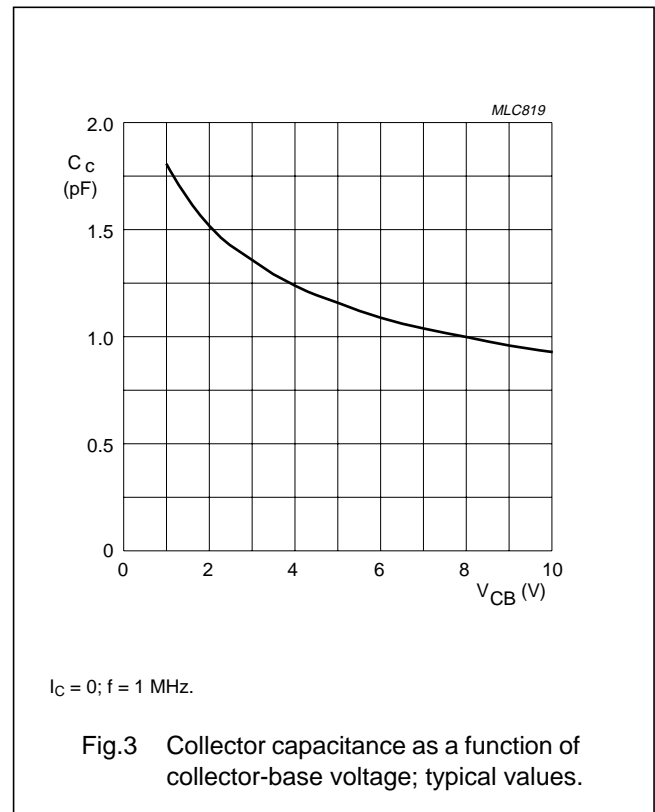
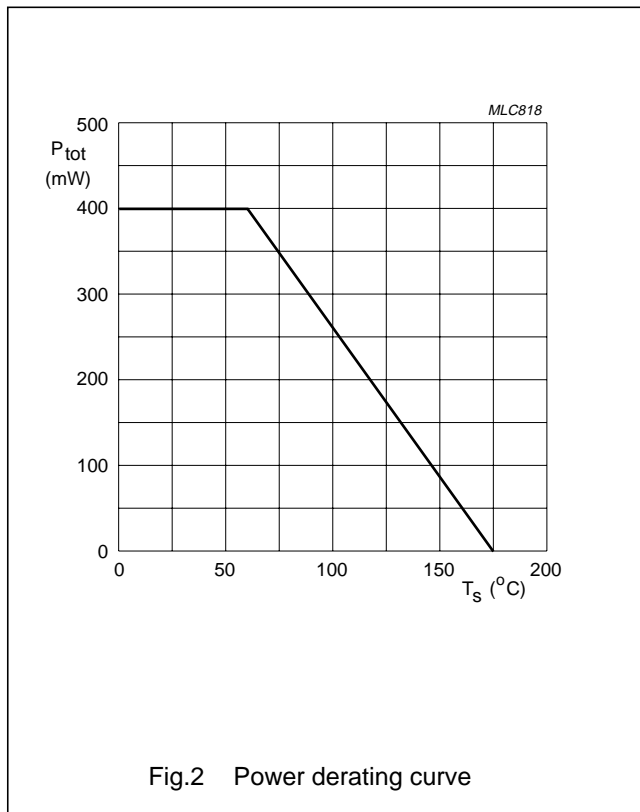

NPN 2 GHz RF power transistor

BFG10; BFG10/X

APPLICATION INFORMATION

RF performance at $T_{amb} = 25\text{ }^{\circ}\text{C}$ in a common-emitter test circuit (see Fig.7).

MODE OF OPERATION	f (GHz)	V _{CE} (V)	I _{CQ} (mA)	P _L (mW)	G _p (dB)	η_c (%)
Pulsed, class-AB, duty cycle: < 1 : 8	1.9	3.6	1	200	>5 typ. 7	>50 typ. 60

Ruggedness in class-AB operation

The BFG10 is capable of withstanding a load mismatch corresponding to VSWR = 8 : 1 through all phases, at rated output power under pulsed conditions up to a supply voltage of 7 V, f = 1.9 GHz and a duty cycle of 1 : 8.

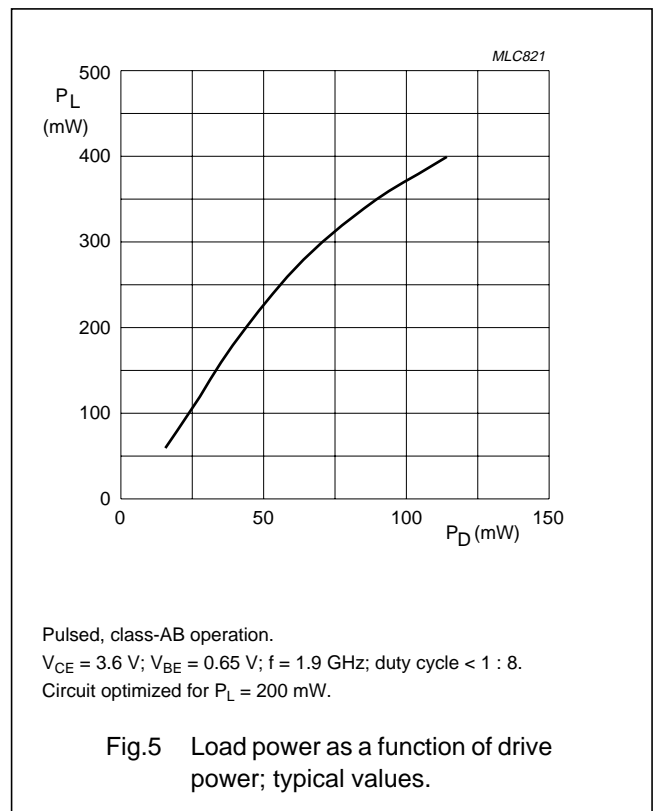
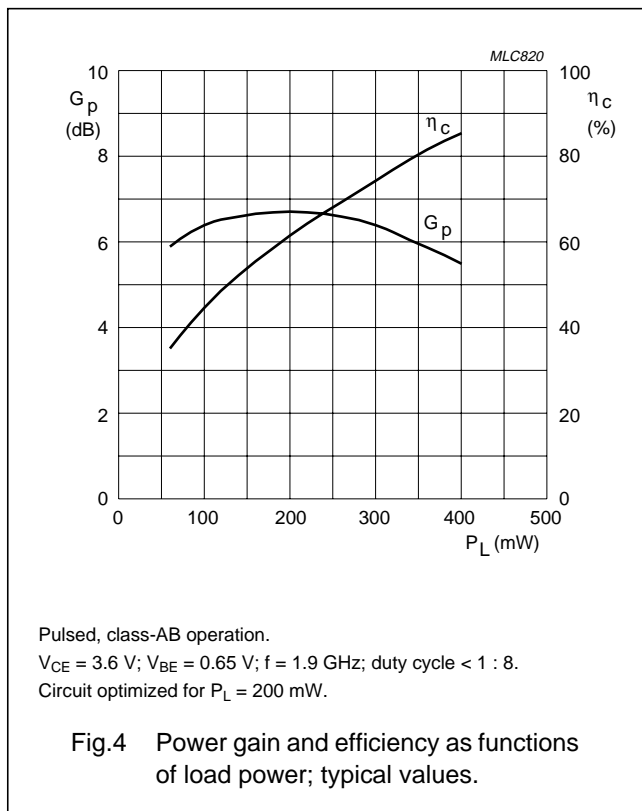

NPN 2 GHz RF power transistor

BFG10; BFG10/X

SPICE parameters for the BFG10 crystal

SEQUENCE No.	PARAMETER	VALUE	UNIT
1	IS	2.714	fA
2	BF	102.8	–
3	NF	0.998	–
4	VAF	28.12	V
5	IKF	6.009	A
6	ISE	403.2	pA
7	NE	2.937	–
8	BR	31.01	–
9	NR	0.999	–
10	VAR	2.889	V
11	IKR	0.284	A
12	ISC	1.487	fA
13	NC	1.100	–
14	RB	3.500	Ω
15	IRB	1.000	μA
16	RBM	3.500	Ω
17	RE	0.217	Ω
18	RC	0.196	Ω
19 ⁽¹⁾	XTB	0.000	–
20 ⁽¹⁾	EG	1.110	eV
21 ⁽¹⁾	XTI	3.000	–
22	CJE	5.125	pF
23	VJE	0.600	V
24	MJE	0.367	–
25	TF	12.07	ps
26	XTF	99.40	–
27	VTF	7.220	V
28	ITF	3.950	A
29	PTF	0.000	deg
30	CJC	2.327	pF
31	VJC	0.668	V
32	MJC	0.398	–
33	XCJC	0.160	–
34 ⁽¹⁾	TR	0.000	ns
35 ⁽¹⁾	CJS	0.000	F
36 ⁽¹⁾	VJS	750.0	mV
37 ⁽¹⁾	MJS	0.000	–
38	FC	0.652	–

Note

1. These parameters have not been extracted, the default values are shown.

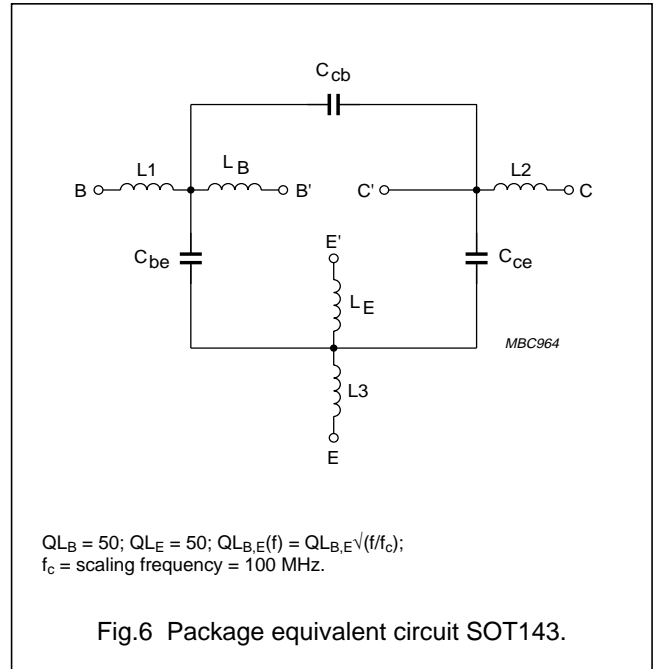

List of components (see Fig.6)

DESIGNATION	VALUE	UNIT
C _{be}	84	fF
C _{cb}	17	fF
C _{ce}	191	fF
L1	0.12	nH
L2	0.21	nH
L3	0.06	nH
L _B	0.95	nH
L _E	0.40	nH

NPN 2 GHz RF power transistor

BFG10; BFG10/X

Test circuit information

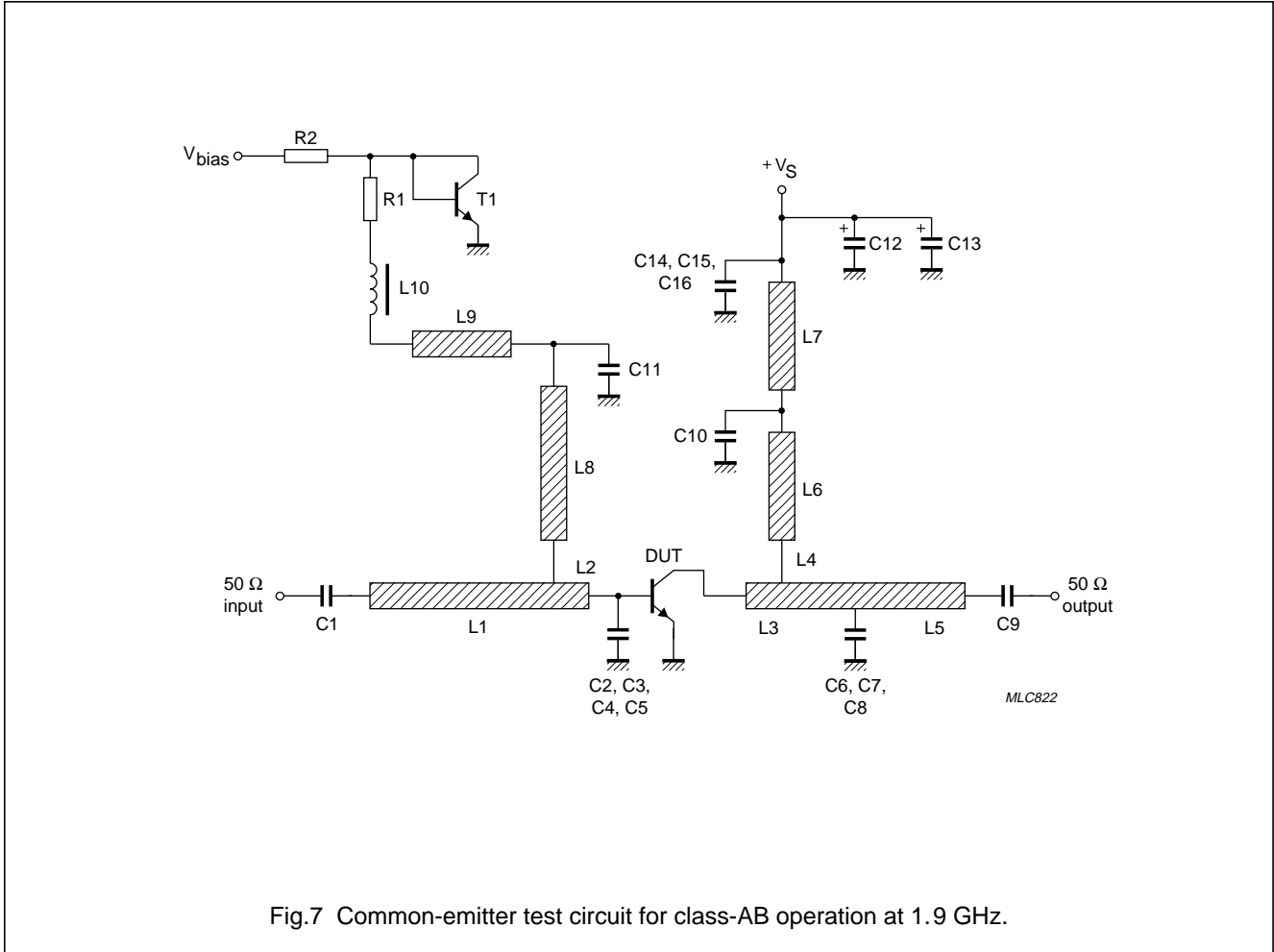

Fig.7 Common-emitter test circuit for class-AB operation at 1.9 GHz.

NPN 2 GHz RF power transistor

BFG10; BFG10/X

List of components used in test circuit (see Fig.7)

COMPONENT	DESCRIPTION	VALUE	DIMENSIONS	CATALOGUE No.
C1, C9, C10, C11	multilayer ceramic chip capacitor; note 1	24 pF		
C2, C3, C4, C5, C6, C7	multilayer ceramic chip capacitor; note 1	0.86 pF		
C8	multilayer ceramic chip capacitor; note 1	1.1 pF		
C12, C13	electrolytic capacitor	470 μ F; 10 V		2222 031 34471
C14, C15, C16	multilayer ceramic chip capacitor; note 1	10 nF		
L1	stripline; note 2		length 28.5 mm width 0.93 mm	
L2	stripline; note 2		length 2.3 mm width 0.93 mm	
L3	stripline; note 2		length 3.1 mm width 0.93 mm	
L4	stripline; note 2		length 3.3 mm width 0.93 mm	
L5	stripline; note 2		length 16.3 mm width 0.93 mm	
L6	stripline; note 2		length 10 mm width 0.93 mm	
L7	stripline; note 2		length 4.4 mm width 0.4 mm	
L8	stripline; note 2		length 19.3 mm width 0.93 mm	
L9	stripline; note 2		length 19.7 mm width 0.4 mm	
L10	micro choke			
T1	BD228			
R1	metal film resistor	20 Ω ; 0.4 W		2322 157 10209
R2	metal film resistor	530 Ω ; 0.4 W		2322 157 15301

Notes

1. American Technical Ceramics (ATC) capacitor, type 100A or other capacitor of the same quality.
2. The striplines are on a $\frac{1}{32}$ inch double copper-clad printed-circuit board with PTFE fibre-glass dielectric ($\epsilon_r = 6$).

NPN 2 GHz RF power transistor

BFG10; BFG10/X

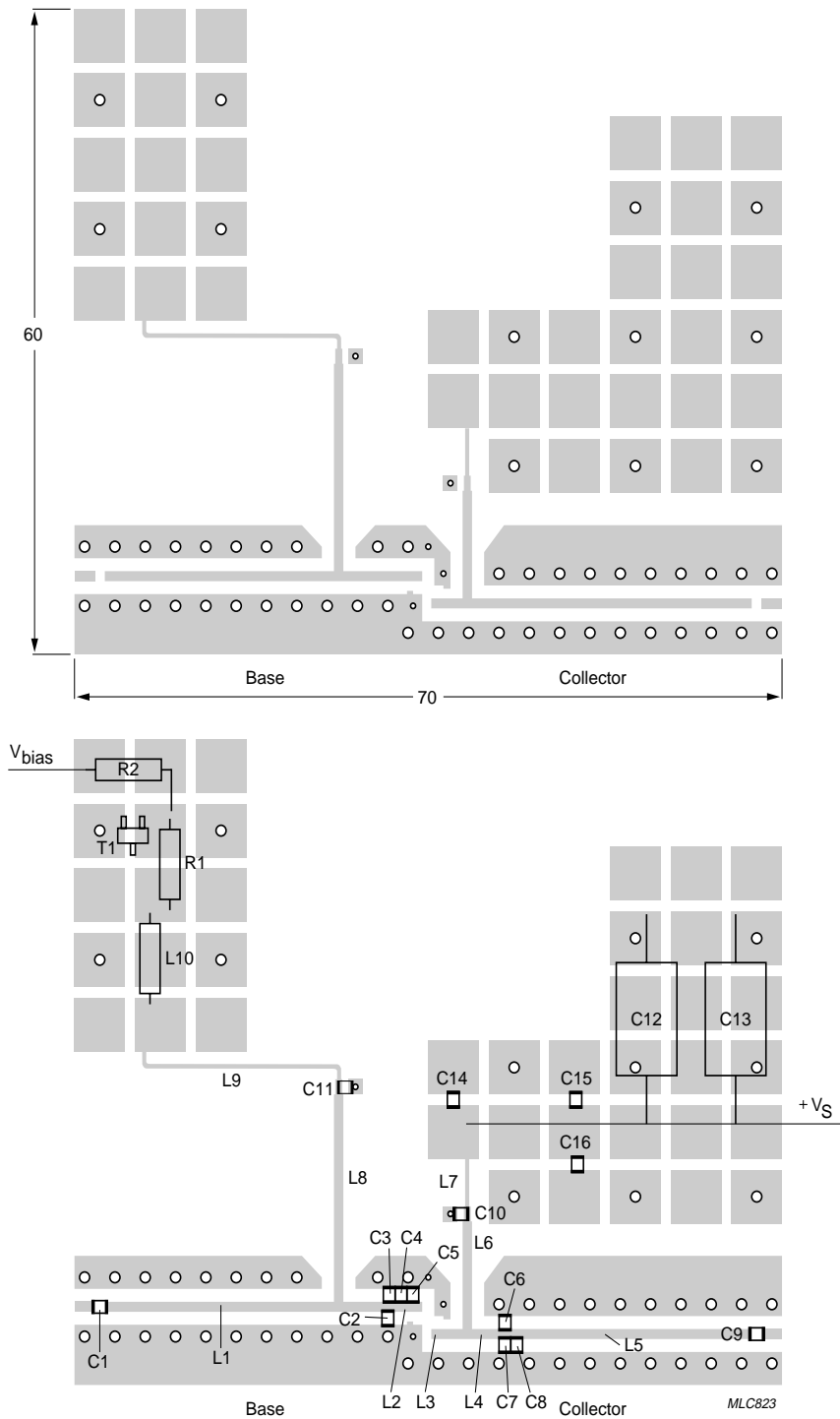

Dimensions in mm.

The components are situated on one side of the copper-clad PTFE microfibre-glass board, the other side is not etched and serves as a ground plane. Earth connections from the component side to the ground plane are made by through metallization.

Fig.8 Printed-circuit board and component lay-out for common-emitter test circuit in Fig.7.

NPN 2 GHz RF power transistor

BFG10; BFG10/X

PACKAGE OUTLINE

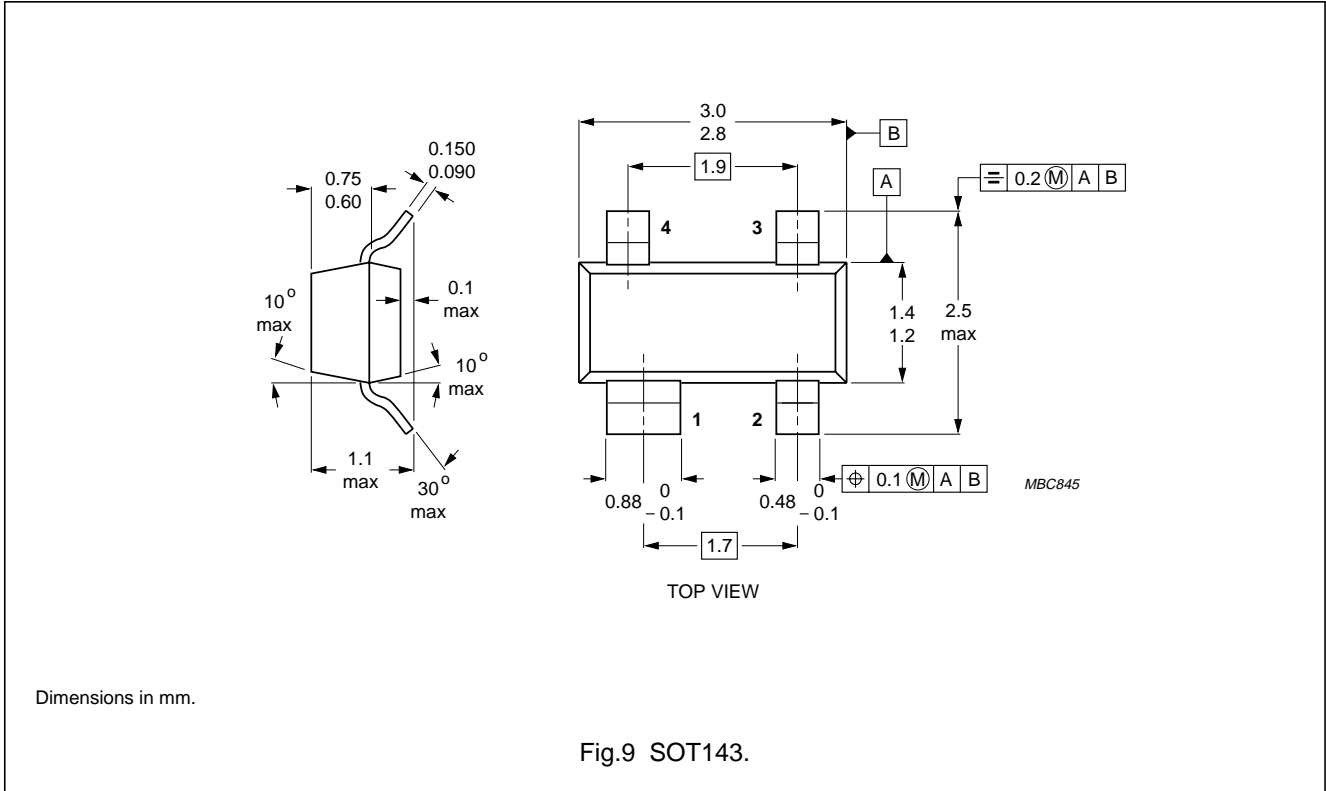

NPN 2 GHz RF power transistor

BFG10; BFG10/X

DEFINITIONS

Data Sheet Status	
Objective specification	This data sheet contains target or goal specifications for product development.
Preliminary specification	This data sheet contains preliminary data; supplementary data may be published later.
Product specification	This data sheet contains final product specifications.
Limiting values	
Limiting values given are in accordance with the Absolute Maximum Rating System (IEC 134). Stress above one or more of the limiting values may cause permanent damage to the device. These are stress ratings only and operation of the device at these or at any other conditions above those given in the Characteristics sections of the specification is not implied. Exposure to limiting values for extended periods may affect device reliability.	
Application information	
Where application information is given, it is advisory and does not form part of the specification.	

LIFE SUPPORT APPLICATIONS

These products are not designed for use in life support appliances, devices, or systems where malfunction of these products can reasonably be expected to result in personal injury. Philips customers using or selling these products for use in such applications do so at their own risk and agree to fully indemnify Philips for any damages resulting from such improper use or sale.